

BELIEVE 3666F

64 7/8" x 35" x 24"



PRODUCT DESCRIPTION:

Adjustable feet
 Transitional style
 Gloss finish resistant to stains and discoloration
 Acrylic thermoformed and reinforced with fiberglass

5 days

| | |
|--------------------------------------|---------------------------------|
| WATER CAPACITY: 78 gallons | IMMERSION: 17 1/2 po |
| BOX SIZE: 68" X 37" X 25" | |
| NET WEIGHT: 125 lbs | GROSS WEIGHT: 143 lbs |

GENERAL OPTIONS

| | |
|--|------------------|
| Acrylic Colors: White | Standard |
| Nuance*: (Allow 3 weeks delivery) | |
| Chromotherapy 1 light (Specify trim color) | 17.99999.0000.00 |
| Chromotherapy 2 lights (Specify trim color) | 17.99999.0001.00 |
| Chromotherapy 4 lights (Specify trim color) | 17.99999.0002.00 |
| Handle (1) (centered overflow's opposite side) | 95.7077.106.XX |
| D105 Waste (20") Chrome | 62.4020.102.60 |
| Drain Adapter D-111-ABS 62.6010.103.00 or D-111-PVC 62.6010.104.00 | |
| Gel black neck pillow (12"x 4 1/4 x 1 1/4") | 18.6000.100.20 |
| Rayola** (Specify control color) | |

MASS-AIR/ACTIV-AIR OPTIONS

| | |
|--|----------------|
| Mass-Air Jet finish: White/Chrome | Standard |
| Others: Chrome/Chrome | |
| Activ-Air Jet finish: Chrome, White | Standard |
| Blower Hose extension 96" | 95.5013.168.00 |
| 144" Extension cord | 95.3012.101.00 |

* Blower(s) must be installed in a remote location, extensions(s) provided.

*Customized products, non cancellable, non returnable.

**Not available with a neck pillow.

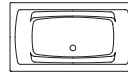

Bathtub only

BE3666F

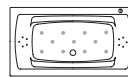

Mass-Air

BE3666FM*

Included: 21 (11-10) injectors, Optima blower 750W (1 1/2 h.p.) with 300W heating element, 6' blower hose extension and backlit electronic control.

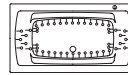

Activ-Air

BE3666FA*

Included: 48 micro-jets, Optima blower 750W (1 1/2 h.p.) with 300W heating element, 6' blower hose extension and backlit electronic control.

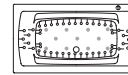

Mass-Air/Activ-Air Combo

BE3666FCMA*

Included: 48 Activ-Air micro-jets, 11 Mass-Air injectors, two Optima blowers 750W (1 1/2 h.p.) with 300W heating element, two 6' blower hose extension and backlit electronic control.



COMPLIANCE ATTESTATION
 Standard bathtubs
 CAN / CSA.B45.5
 Hydromassage Standards
 CAN / CSA.B45.10 / CSA.C22.2 / UL-1795



Certification ECORESPONSIBLE
 First manufacturer of bathroom products in
 North America to be certified ecoresponsible.



Produits Neptune

6835, Picard street, Saint-Hyacinthe (Quebec) J2S 1H3
 Phone: (450) 773-7058 - produitsneptune.com

REV: 08-19



Produits Neptune

BELIEVE 3666 F

Bathtub

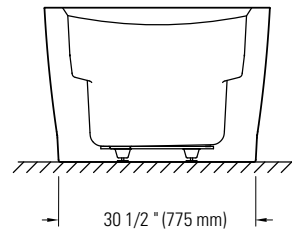
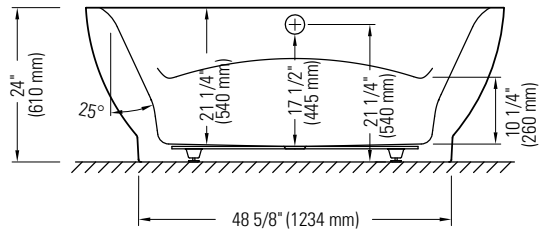
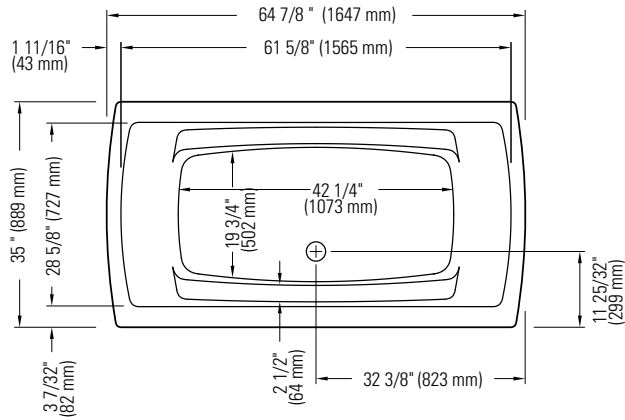

Left view

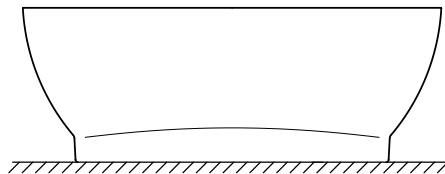

*All dimensions are approximate and subject to change without notice.
Please refer to the installation guide before beginning the installation