

# VAPORA 3660

60" x 36" x 20 3/4"



## PRODUCT DESCRIPTION:

Adjustable feet  
 Transitional style  
 Gloss finish resistant to stains and discoloration  
 Acrylic thermoformed and reinforced with fiberglass

5 days

## WATER CAPACITY:

59 gallons

## IMMERSION:

15 1/4 po

## BOX SIZE:

## NET WEIGHT:

## GROSS WEIGHT:

## GENERAL OPTIONS

**Acrylic Colors:** White Standard  
 Biscuit\* and Bone\* (Allow 3 weeks delivery) Standard

**Others\*:** (Allow 6 to 8 weeks delivery)

<b>Chromotherapy 1 light</b> (Specify trim color)	17.99999.0000.00
<b>Chromotherapy 2 lights</b> (Specify trim color)	17.99999.0001.00
<b>Chromotherapy 4 lights</b> (Specify trim color)	17.99999.0002.00
<b>Handle</b> (max. 2) (submit drawing with order)	95.7077.106.XX
<b>D105 Waste</b> (20") Chrome	62.4020.102.60
<b>Gel black neck pillow</b> (12"x 4 1/4 x 1 1/4")	18.6000.100.20

**Rayola\*\*** (Specify control color)

## WHIRLPOOL OPTIONS

**A bathtub fitted with back jets may cause the pump to protrude by +/- 3" from the overall dimension.**

**Pump is located behind seat**

**Whirlpool Jet finish:** Chrome, White, Biscuit, Bone Standard

**110v Inline Heater** (1)

**Ozonator**

**TurboAir** (1)

## MASS-AIR/ACTIV-AIR OPTIONS

**Mass-Air Jet finish:** White/Chrome Standard  
 Biscuit/Chrome  
 Bone/Chrome

**Others:** Chrome/Chrome

<b>Activ-Air Jet finish:</b> Chrome, White, Biscuit, Bone	Standard
<b>Blower Hose extension 36"</b>	95.5013.116.00
<b>Blower Hose extension 72"</b>	95.5013.167.00
<b>Blower Hose extension 96"</b>	95.5013.168.00
<b>144" Extension cord</b>	95.3012.101.00

**An extension cord and blower hose extension are necessary when the blower is located more than 2' from the electronic control, not available on whirlpool combos.**

## TONIC OPTIONS

**Waste included for bathtub with Tonic system:** Chrome  
**Tonic Jet finish:** White, Biscuit, Bone, Chrome Standard

\*Customized products, non cancellable, non returnable.

\*\*Not available with a neck pillow.

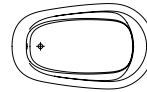

**Bathtub only**

**VA3660**

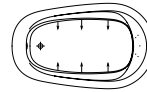

**Whirlpool**

**VA3660T**

Included: 6 turbo jets, 5 micro-rotating back jets, 13 A pump, one diverter valve and electronic control.

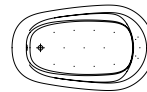

**Mass-Air**

**VA3660M**

Included: 16 (11-5) injectors, Optima blower 750W (1 1/2 h.p.) with 300W heating element and backlit electronic control.

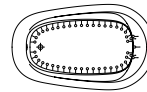

**Activ-Air**

**VA3660A**

Included: 41 micro-jets, Optima blower 750W (1 1/2 h.p.) with 300W heating element and backlit electronic control.

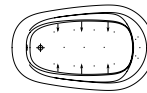

**Mass-Air/Whirlpool Combo**

**VA3660C**

Included: 6 turbo jets, 5 micro-rotating back jets, 11 Mass-Air injectors, 13 A pump, Optima blower 750W (1 1/2 h.p.) with 300W heating element, one diverter valve and backlit electronic control.

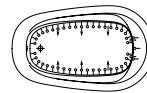

**Activ-Air/Whirlpool Combo**

**VA3660CA**

Included: 6 turbo jets, 5 micro-rotating back jets, 35 Activ-Air micro-jets, 13 A pump, Optima blower 750W (1 1/2 h.p.) with 300W heating element, one diverter valve and backlit electronic control.

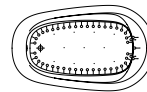

**Mass-Air/Activ-Air Combo**

**VA3660CMA**

Included: 41 Activ-Air micro-jets, 11 Mass-Air injectors, two Optima blowers 750W (1 1/2 h.p.) with 300W heating element and backlit electronic control.

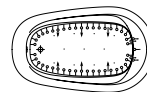

**Activ-Air/Mass-Air/Whirlpool Combo**

**VA3660TAM**

Included: 6 turbo jets, 5 micro-rotating back jets, 35 Activ-Air micro-jets, 11 Mass-Air injectors, 13 A pump, two Optima blowers 750W (1 1/2 h.p.) with 300W heating element, one diverter valve and backlit electronic control.

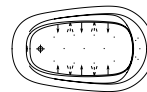

**Tonic**

**VA3660Q**

Included: 8 Oxygen jets, Optima blower 750W (1 1/2 h.p.) with 300W heating element, Syllent pump with integrated in-line heater, 4 Chromotherapy lights and backlit tactile electronic control.



Intertek

**COMPLIANCE ATTESTATION**  
 Standard bathtubs  
 CAN / CSA.B45.5  
 Hydromassage Standards  
 CAN / CSA.B45.10 / CSA.C22.2 / UL-1795



**Certification ECORESPONSIBLE**  
 First manufacturer of bathroom products in North America to be certified ecoresponsible.



**Produits Neptune**  
 6835, Picard street, Saint-Hyacinthe (Quebec) J2S 1H3  
 Phone: (450) 773-7058 - Fax: (450) 773-5063  
 produitsneptune.com



Produits Neptune

# VAPORA 3660

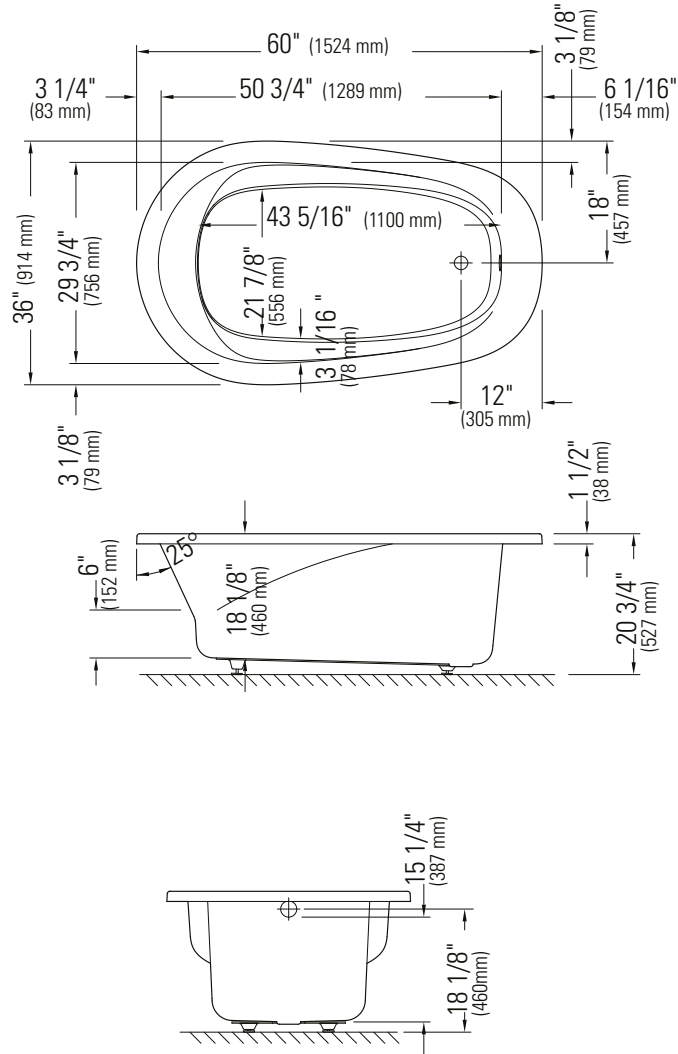

\*A bathtub fitted with back jets can cause the pump to protrude by approximately 3" from the overall dimension.

\*\*All dimensions are approximate and subject to change without notice. Please refer to the installation guide before beginning the installation