



PRODUCT DESCRIPTION:

Adjustable feet
 Transitional style
 Gloss finish resistant to stains and discoloration
 Acrylic thermoformed and reinforced with fiberglass

5 days

WATER CAPACITY: 95 gallons	IMMERSION: 16 1/4 po
BOX SIZE: 74" x 42" x 24 1/2"	
NET WEIGHT: 74 lbs	GROSS WEIGHT: 91 lbs

GENERAL OPTIONS

Acrylic Colors: White Biscuit* and Bone* (Allow 3 weeks delivery)	Standard Standard
Others*: (Allow 6 to 8 weeks delivery)	
Chromotherapy 1 light (Specify trim color)	17.99999.0000.00
Chromotherapy 2 lights (Specify trim color)	17.99999.0001.00
Chromotherapy 4 lights (Specify trim color)	17.99999.0002.00
Handle (1) (centered overflow's opposite side)	95.7077.106.XX
D106 Waste (27") Chrome	62.4027.103.60
Gel black neck pillow (12" x 4 1/4 x 1 1/4")	18.6000.100.20
Rayola** (Specify control color)	

WHIRLPOOL OPTIONS

A bathtub fitted with back jets may cause the pump to protrude by +/- 3" from the overall dimension.

Pump is located behind seat (right side)

Whirlpool Jet finish: Chrome, White, Biscuit, Bone	Standard
110v Inline Heater (1)	

Ozonator

TurboAir (1)

MASS-AIR/ACTIV-AIR OPTIONS

Mass-Air Jet finish: White/Chrome Biscuit/Chrome Bone/Chrome	Standard
Others: Chrome/Chrome	

Activ-Air Jet finish: Chrome, White, Biscuit, Bone	Standard
Blower Hose extension 36"	95.5013.116.00
Blower Hose extension 72"	95.5013.167.00
Blower Hose extension 96"	95.5013.168.00
144" Extension cord	95.3012.101.00

An extension cord and blower hose extension are necessary when the blower is located more than 2' from the electronic control, not available on whirlpool combos.

TONIC OPTIONS

Waste included for bathtub with Tonic system: Chrome	
Tonic Jet finish: White, Biscuit, Bone, Chrome	Standard

*Customized products, non cancellable, non returnable.

**Not available with a neck pillow.

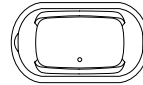

Bathtub only

REV4272

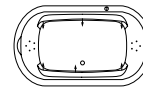

Whirlpool

REV4272T

Included: 6 turbo jets, 10 micro-rotating back jets, 13 A pump, two diverter valves and electronic control.

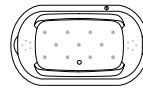

Mass-Air

REV4272M

Included: 21 (11-10) injectors, Optima blower 750W (1 1/2 h.p.) with 300W heating element and backlit electronic control.

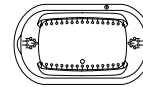

Activ-Air

REV4272A

Included: 48 micro-jets, Optima blower 750W (1 1/2 h.p.) with 300W heating element and backlit electronic control.

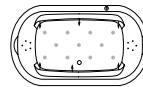

Mass-Air/Whirlpool Combo

REV4272C

Included: 6 turbo jets, 10 micro-rotating back jets, 11 Mass-Air injectors, 13 A pump, Optima blower 750W (1 1/2 h.p.) with 300W heating element, two diverter valves and backlit electronic control.

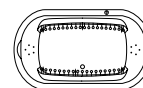

Activ-Air/Whirlpool Combo

REV4272CA

Included: 6 turbo jets, 10 micro-rotating back jets, 40 Activ-Air micro-jets, 13 A pump, Optima blower 750W (1 1/2 h.p.) with 300W heating element, two diverter valves and backlit electronic control.

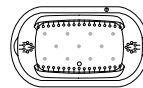

Mass-Air/Activ-Air Combo

REV4272CMA

Included: 48 Activ-Air micro-jets, 11 Mass-Air injectors, two Optima blowers 750W (1 1/2 h.p.) with 300W heating element and backlit electronic control.

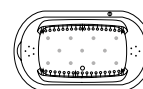

Activ-Air/Mass-Air/Whirlpool Combo

REV4272TAM

Included: 6 turbo jets, 10 micro-rotating back jets, 40 Activ-Air micro-jets, 11 Mass-Air injectors, 13 A pump, two Optima blowers 750W (1 1/2 h.p.) with 300W heating element, two diverter valves and backlit electronic control.

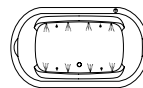

Tonic

REV4272Q

Included: 8 Oxygen jets, Optima blower 750W (1 1/2 h.p.) with 300W heating element, Syllent pump with integrated in-line heater, 4 Chromotherapy lights and backlit tactile electronic control.



Intertek

COMPLIANCE ATTESTATION
 Standard bathtubs
 CAN / CSA.B45.5
 Hydromassage Standards
 CAN / CSA.B45.10 / CSA.C22.2 / UL-1795



Certification ECORESPONSIBLE
 First manufacturer of bathroom products in North America to be certified ecoresponsible.



Produits Neptune
 6835, Picard street, Saint-Hyacinthe (Quebec) J2S 1H3
 Phone: (450) 773-7058 - Fax: (450) 773-5063
 produitsneptune.com



Produits Neptune

REVELATION 4272

Bathtub

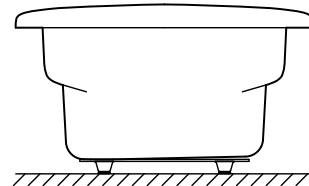
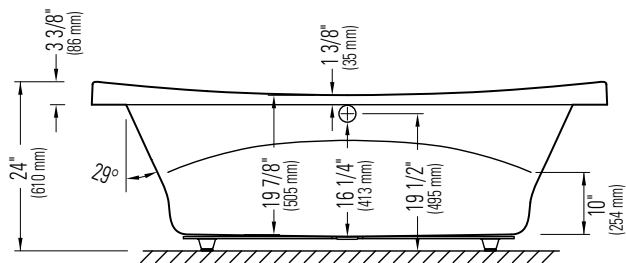
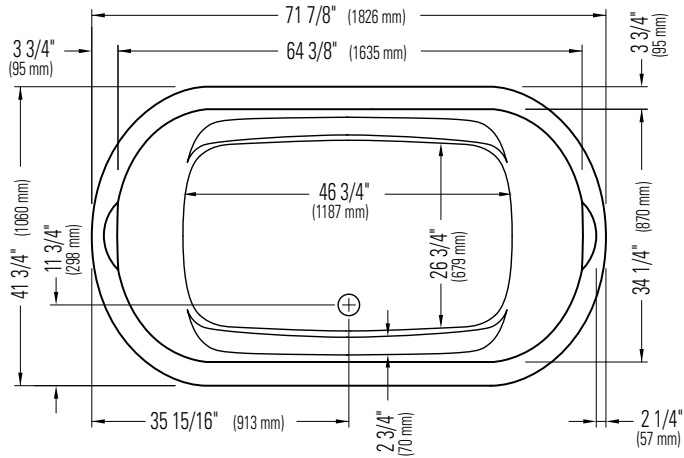

*A bathtub fitted with back jets can cause the pump to protrude by approximately 3" from the overall dimension.

**All dimensions are approximate and subject to change without notice. Please refer to the installation guide before beginning the installation