

MÉLIA 60

60 3/8" x 32 3/4" x 19 1/2"



PRODUCT DESCRIPTION:

Adjustable feet
Transitional style
Gloss finish resistant to stains and discoloration
Acrylic thermoformed and reinforced with fiberglass

5 days

WATER CAPACITY: 51 gallons	IMMERSION: 13 1/8 po
BOX SIZE: 63" x 33 1/4" x 23"	
NET WEIGHT: 53 lbs	GROSS WEIGHT: 71 lbs

GENERAL OPTIONS

Acrylic Colors: White Standard
Biscuit* and Bone* (Allow 3 weeks delivery) Standard

Others*: (Allow 6 to 8 weeks delivery)

Chromotherapy 1 light (Specify trim color)	17.99999.0000.00
Chromotherapy 2 lights (Specify trim color)	17.99999.0001.00
Chromotherapy 4 lights (Specify trim color)	17.99999.0002.00
Handle (max. 2) (submit drawing with order)	95.7077.106.XX
D105 Waste (20") Chrome	62.4020.102.60
Gel black neck pillow (12"x 4 1/4 x 1 1/4")	18.6000.100.20

WHIRLPOOL OPTIONS

A bathtub fitted with back jets may cause the pump to protrude by +/- 3" from the overall dimension.

Whirlpool Jet finish: Chrome, White, Biscuit, Bone Standard

110v Inline Heater (1)

Ozonator

Turbo Air (1)

MASS-AIR/ACTIV-AIR OPTIONS

Mass-Air Jet finish: White/Chrome Standard
Biscuit/Chrome
Bone/Chrome

Others: Chrome/Chrome

Activ-Air Jet finish: Chrome, White, Biscuit, Bone	Standard
Blower Hose extension 36"	95.5013.116.00
Blower Hose extension 72"	95.5013.167.00
Blower Hose extension 96"	95.5013.168.00
144" Extension cord	95.3012.101.00

An extension cord and blower hose extension are necessary when the blower is located more than 2' from the electronic control, not available on whirlpool combos.

TONIC OPTIONS

Waste included for bathtub with Tonic system: Chrome

Tonic Jet finish: White, Biscuit, Bone, Chrome Standard

*Customized products, non cancellable, non returnable.



Bathtub only

ME60

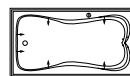

Whirlpool

ME60T

Included: 6 turbo jets, 5 micro-rotating back jets, 13 A pump, diverter valve and electronic control.

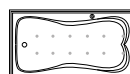

Mass-Air

ME60M

Included: 12 (10-2) injectors, Optima blower 750W (1 1/2h.p.) with 300W heating element and backlit electronic control.

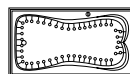

Activ-Air

ME60A

Included: 40 micro-jets, Optima blower 750W (1 1/2h.p.) with 300W heating element and backlit electronic control.

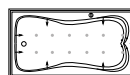

Mass-Air/Whirlpool Combo

ME60C

Included: 6 turbo jets, 5 micro-rotating back jets, 10 Mass-Air injectors, 13 A pump, Optima blower 750W (1 1/2h.p.) with 300W heating element, diverter valve and backlit electronic control.

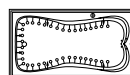

Activ-Air/Whirlpool Combo

ME60CA

Included: 6 turbo jets, 5 micro-rotating back jets, 31 Activ-Air micro-jets, 13 A pump, Optima blower 750W (1 1/2h.p.) with 300W heating element, diverter valve and backlit electronic control.

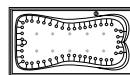

Mass-Air/Activ-Air Combo

ME60CMA

Included: 40 Activ-Air micro-jets, 10 Mass-Air injectors, two Optima blowers 750W (1 1/2h.p.) with 300W heating element and backlit electronic control.

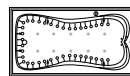

Activ-Air/Mass-Air/Whirlpool Combo

ME60TAM

Included: 6 turbo jets, 5 micro-rotating back jets, 31 Activ-Air micro-jets, 10 Mass-Air injectors, 13 A pump, two Optima blowers 750W (1 1/2h.p.) with 300W heating element, diverter valve and backlit electronic control.



Tonic

ME60Q

Included: 8 Oxygen jets, Optima blower 750W (1 1/2 h.p.) with 300W heating element, Syllent pump with integrated in-line heater, 4 Chromotherapy lights and backlit tactile electronic control.



Intertek

COMPLIANCE ATTESTATION
Standard bathtubs
CAN / CSA.B45.5
Hydromassage Standards
CAN / CSA.B45.10 / CSA.C22.2 / UL-1795



Certification ECORESPONSIBLE
First manufacturer of bathroom products in North America to be certified ecoresponsible.



Produits Neptune

6835, Picard street, Saint-Hyacinthe (Quebec) J2S 1H3
Phone: (450) 773-7058 - Fax: (450) 773-5063
produitsneptune.com



Produits Neptune

MÉLIA 60

Bathtub

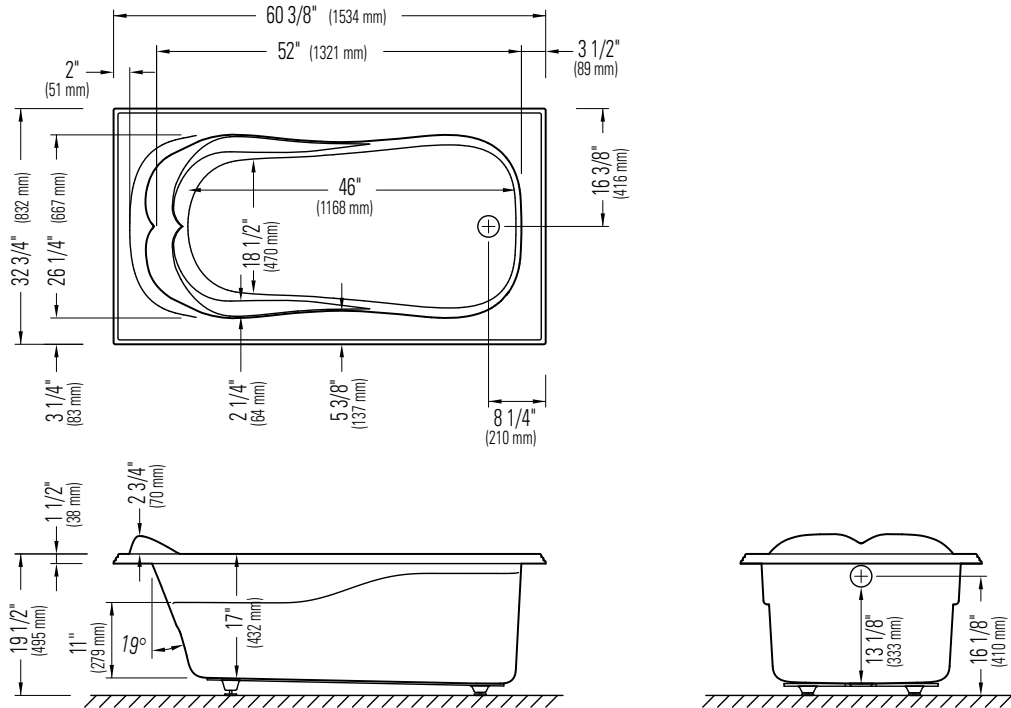

*A bathtub fitted with back jets can cause the pump to protrude by approximately 3" from the overall dimension.

**All dimensions are approximate and subject to change without notice. Please refer to the installation guide before beginning the installation